

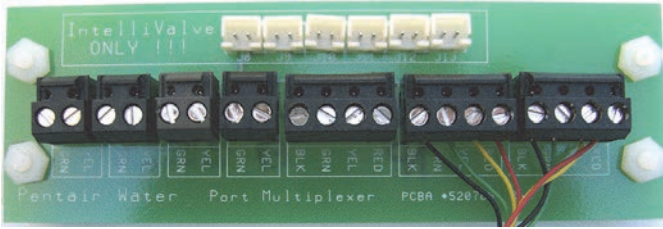

# SERIAL COM PORT EXPANSION BOARD FOR USE WITH INTELLITOUCH® AND EASYTOUCH® CONTROL SYSTEMS



## INSTALLATION AND USER'S GUIDE

IMPORTANT SAFETY INSTRUCTIONS  
READ AND FOLLOW ALL INSTRUCTIONS  
SAVE THESE INSTRUCTIONS

## CONTENTS

Introduction .....	1
Load Center Installation .....	1
Mounting the Expansion Board .....	2
Connecting Accessories to the Expansion Board .....	2
Wiring a Salt Chlorine Generator .....	5
IntelliFlo Pump Wiring Pinouts .....	5

### Serial COM Port Expansion Kit Contents (P/N 520818)

The following items are included in the kit:

- One Serial COM Port Expansion Board populated with three four position and four two position screw terminal blocks.
- 12 inch long, four-conductor cable attached to two four-position terminal blocks.
- Four-screws, two Expansion Board brackets
- Installation Guide (this manual)

### Technical Support

Contact Technical Support at:

**Sanford, North Carolina** (8 A.M. to 4:30 P.M.)

Phone: (800) 831-7133

**Moorpark, California** (8 A.M. to 4:30 P.M.)

Phone: (800) 831-7133

Fax: (800) 284-4151

Web sites: visit [www.pentairpool.com](http://www.pentairpool.com) and [www.staritepool.com](http://www.staritepool.com)

### Related IntelliTouch® Control System Manual

IntelliTouch® Control System Installation and User's Guide (P/N 521075)

EasyTouch® Control System Indoor Control Panel Installation and User's Guide (P/N 520617)

## IMPORTANT WARNING AND SAFETY INSTRUCTIONS



**DANGER**

**SERIOUS BODILY INJURY OR DEATH CAN RESULT IF THIS PRODUCT IS NOT INSTALLED AND USED CORRECTLY. INSTALLERS, POOL OPERATORS AND POOL OWNERS MUST READ THESE WARNINGS AND ALL INSTRUCTIONS BEFORE USING THIS PRODUCT.**



**WARNING**

Most states and local codes regulate the construction, installation, and operation of public pools and spas, and the construction of residential pools and spas. It is important to comply with these codes, many of which directly regulate the installation and use of this product. Consult your local building and health codes for more information.



**IMPORTANT NOTICE - Attention Installer:** This Installation and User's Guide ("Guide") contains important information about the installation, operation and safe use of this underwater pool and spa light. This Guide should be given to the owner and/or operator of this equipment.



**WARNING**

Before installing this product, read and follow all warning notices and instructions in this Guide. Failure to follow warnings and instructions can result in severe injury, death, or property damage.

Call (800) 831-7133 for additional free copies of these instructions.

Please refer to [www.pentairpool.com](http://www.pentairpool.com) for more information related to this products.



**DANGER**



**RISK OF ELECTRICAL SHOCK OR ELECTROCUTION: BEFORE WORKING ON OR INSTALLING THIS PRODUCT, always disconnect power to the pool and/or spa lights at the source circuit breaker from the light before servicing the light. Failure to do so could result in death or serious injury to service person, pool users or others due to electric shock. When installing and using this electrical equipment, basic safety precautions should always be followed.**



**WARNING**

**For countries in compliance with International Electrotechnical Commission (IEC) regulatory standards:** The light fixture must be

installed by a licensed or certified electrician or a qualified pool service person, in accordance with current IEC 364-7-702 and all applicable local codes and ordinance. Improper installation will create an electrical hazard, which could result in death or serious injury to pool user, installer or other due to electrical shock and may also cause damage to the property.

## Introduction

The Serial COM port expansion board can be used with IntelliTouch® and EasyTouch® Control Systems. Connect accessory equipment to the Expansion Board as shown:

**Six two-pin connectors:**  
For future use.

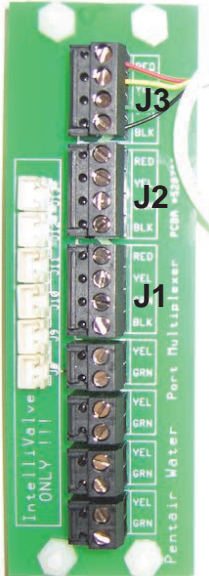

Expansion Board

**Three four-pin screw terminal blocks (COM ports).** One COM port must be connected to the IntelliTouch® Control System Personality Board or the EasyTouch® Control System Main Board. For use with IntelliTouch control system iS10 Remote Controller, QuickTouch®, and MobileTouch® Wireless Controllers, Indoor Control Panel, i5x and i10x Expansion Load Center, EasyTouch control system Control Panel, Wireless Control Panel, ScreenLogic® Interface Protocol Adapter, IntelliChlor® Electronic Chlorine Generator, i-Link™ Protocol Interface adapter, and many other accessories. **Note: The three COM Ports share a common bus. These accessories can attach to any of these ports.**

**Four two-pin non-power screw terminals.** For RS-485 communication to IntelliFlo® Pumps.

## Load Center Installation



**WARNING** Switch OFF the main system power to the load center before making any connections.

1. Unlatch the front door spring latch/latches to open the door.
2. Loosen the two access screws securing the control panel and fold it down.
3. Proceed to **“Mounting the Expansion board,”** on page 2.
4. After the Expansion Board has been mounted and connected, close the control panel into its original position and secure it with the two access screws. Close the load center front door. Fasten the spring latch/latches.

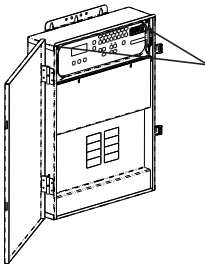

Control panel access screws

Original Load Center Enclosure

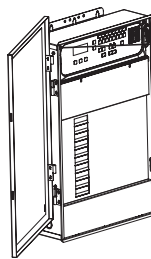

Control panel access screws

New Style Load Center Enclosure

## Mounting the Serial COM Port Expansion Board

**Note:** The Serial COM Port Expansion Board is shipped with the cable connectors plugged in to J2 and J3.

1. Remove the terminal connector J2 on the Expansion Board and connect it to a COM port on the IntelliTouch® Control System Personality Board or EasyTouch® Control System Main Board.

*Note: If this a first time installation, remove one of the existing (empty) terminal connectors from the Personality board main board to allow for the Expansion board terminal connector. You can place the (empty) connector onto the available COM port on the Expansion board.*

**Note:** A typical cable connection would be J3 cable connector remains on the Expansion Board and the other cable connector is attached to the Personality board or EasyTouch® Control System Main Board.

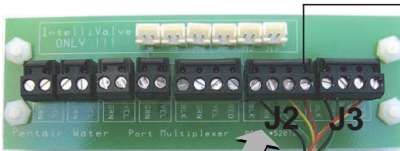

Remove this terminal connector J2 and connect it to an available COM port on the Personality board or EasyTouch® Control System Main Board

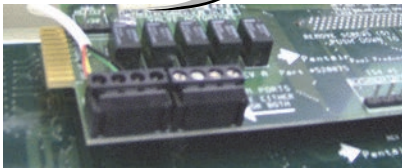

IntelliTouch Control System Personality Board

2. Mount the Expansion board on to the back wall in the low voltage compartment of the Load Center using the four adhesive backed supports.
3. Proceed to “Connecting Accessories to the Expansion Board”.

## Connecting Accessories to the Expansion Board

If you have existing accessories (IntelliChlor® Electronic Chlorine Generator, IntelliFlo® Pump) connected to the IntelliTouch control System Personality Board or EasyTouch Control System Main Board COM port, remove the connector with attached wires and connect the connector to an available terminal on the Expansion board COM port (as shown on page 3).

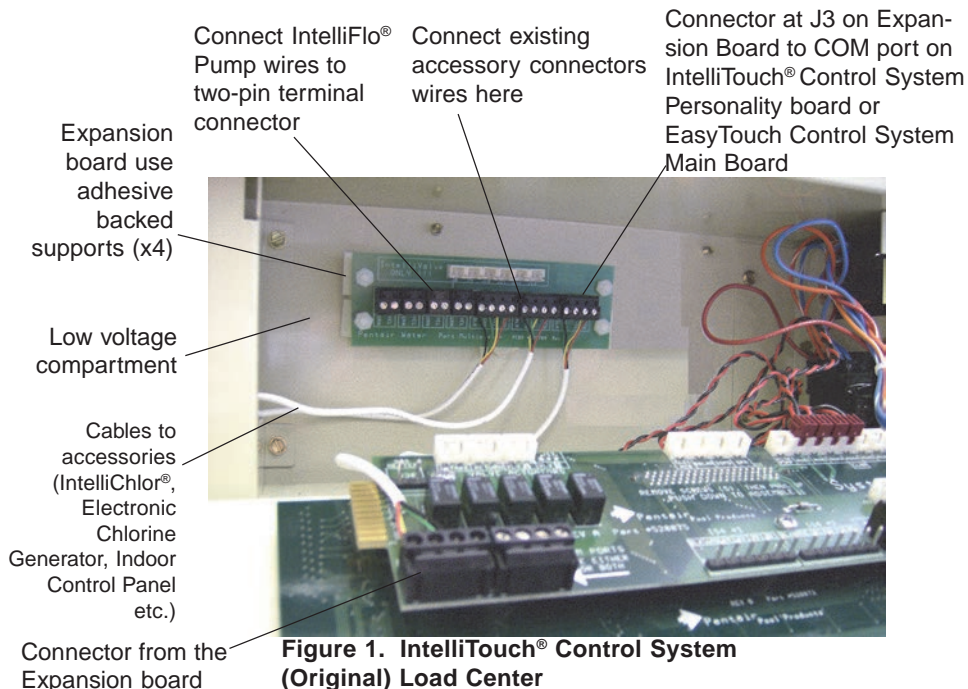

**Figure 1. IntelliTouch® Control System (Original) Load Center**

### Installing the Expansion Board in the EasyTouch® and IntelliTouch® Control System Load Center

1. Remove the two screws from the back of the load center low voltage compartment.
2. Install the two Expansion Board brackets and secure with the two screws.
3. Mount the Expansion Board onto the bracket and secure with the four screws that is provided in the kit.

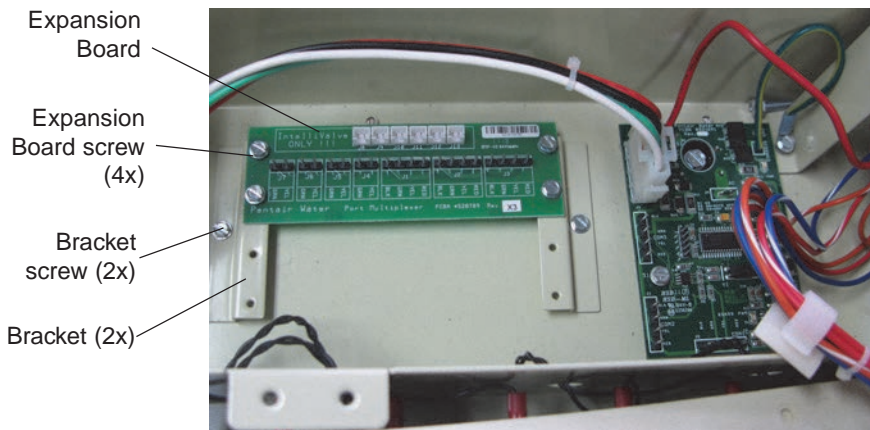

**Figure 2. EasyTouch and IntelliTouch Control System (New Style) Load Center**

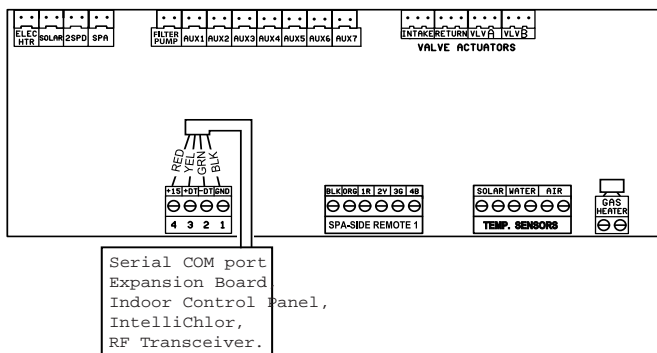

EasyTouch® Main Board COM port location

1. **Expansion board COM port connections:** Connect the four-wire connector from the accessory to the COM port on the Expansion board COM port. Accessories include the IntelliTouch® Control System iS10 Remote Controller, QuickTouch®, MobileTouch® Wireless Controllers, Indoor Control Panel, the EasyTouch Control Systems Control Panel, Wireless Control Panel, the ScreenLogic® Interface Protocol Adapter, or any accessory that does not require a separate power supply.
2. **Connecting COM port terminal connector wires:** Strip back the cable conductors  $\frac{1}{4}$  in. Insert the wires into the screw terminals of one of the COM PORT plugs. Using a small flat-blade screwdriver, secure the wires with the screws. Make sure to match the color coding of the four wires:
  - Pin 4 - Red = +15
  - Pin 3 - Yellow = +DT
  - Pin 2 - Green = -DT
  - Pin 1 - Black = GND
3. **Four two-pin non-power (RS-485) connectors:** Use these connectors to connect to IntelliFlo® Pumps, Load Centers or any accessory that uses a separate power supply.

Note: IntelliValve™ connectors: For future use.

## Wiring a Salt Chlorine Generator to the IntelliTouch® Control System



### IMPORTANT WIRING INFORMATION WHEN USING SALT CHLORINE GENERATORS WITH INTELLITOUCH® CONTROL SYSTEM.

Be sure to check the wire color and function of the salt chlorine generators before attaching to the IntelliTouch® Control System COM port. See the wiring table below.

Commonly used salt chlorine generator wiring is shown in the table below but should still be verified.



**CAUTION!** Failure to wire the salt chlorine generator properly can permanently damage the IntelliTouch control system and the Chlorine Generator.

IntelliTouch COM port wire colors	Function	Chlorine Generator commonly used wire colors
RED YELLOW GREEN BLACK	+15V +DATA -DATA GROUND	RED BLACK YELLOW GREEN

### IntelliFlo® Pump Wiring Pinouts

- Connect pin 6 (green) on the pump cable to pin 2 (green) on the Expansion Board two-pin screw terminal.
- Connect pin 7 (yellow) on the pump cable to pin 3 (yellow) on the Expansion Board two-pin screw terminal.

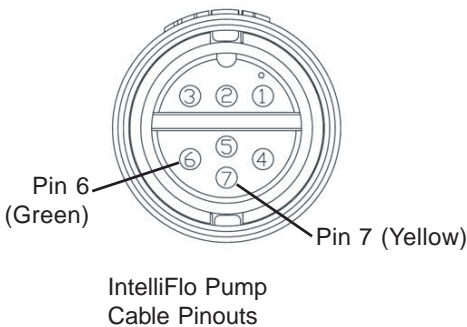

Expansion Board two-pin screw terminal

Yellow Green



screw terminal connector	IntelliFlo (2-wire cable)
2 (GRN)	GREEN (Pin 6)
3 (YEL)	YELLOW (Pin 7)

Pinouts



## Notes



1620 HAWKINS AVE., SANFORD, NC 27330 • (919) 566-8000  
10951 WEST LOS ANGELES AVE., MOORPARK, CA 93021 • (805) 553-5000

[WWW.PENTAIRPOOL.COM](http://WWW.PENTAIRPOOL.COM)

All Pentair trademarks and logos are owned by Pentair, Inc. Pentair Aquatic Systems™, IntelliTouch®, IntelliFlo®, IntelliChlor®, QuickTouch®, MobileTouch®, ScreenLogic® and EasyTouch® are trademarks and/or registered trademarks of Pentair Water Pool and Spa, Inc. and/or its affiliated companies in the United States and/or other countries. Unless expressly noted, names and brands of third parties that may be used in this document are not used to indicate an affiliation or endorsement between the owners of these names and brands and Pentair Water Pool and Spa, Inc. Those names and brands may be the trademarks or registered trademarks of those third parties. Because we are continuously improving our products and services, Pentair reserves the right to change specifications without prior notice. Pentair is an equal opportunity employer.

© 2013 Pentair Aquatic Systems. All rights reserved.  
This document is subject to change without notice.

P/N 520817 REV C 4/13